



DESCRIPTION

The MS3709 is a slim, plug-in pulse shaper (pulse isolator) that accepts pulse train signals from sensors or other devices, shapes these pulses or converts signal levels, and provides isolated single or dual output.

ORDERING CODE

Model **MS3709** - -

Power Supply _____

A: 100 to 240V AC (50 to 60Hz)
D: 24V DC **P:** 100 to 240V DC

Input _____

O: Dry contact or open collector
(Pull-up: Approx. 13V, 3.3kΩ; Threshold voltage: Approx. 2V)

M: Dry contact or open collector
(Pull-up: Approx. 13V, 3.3kΩ; Threshold voltage: Approx. 5V)
* For Azbil's electromagnetic flowmeter MGG10C, etc.

A: AC voltage pulse
(Threshold voltage: Approx. 0.06Vp-p)

D: DC voltage pulse
(Threshold voltage: Approx. 2V)

I: 4 to 20mA DC pulse
(Threshold current: Approx. 8mA)
Note: Threshold current when a 2-wire sensor power supply is specified: Approx. 14mA

Y: Other input signal and/or threshold voltage

Output 1 _____

1: TTL level
2: Open collector
3: Voltage pulse 10V±10%
4: Voltage pulse 12V±10%

Output 2 _____

No code: None
The codes are the same as for Output 1.

Note: When a combination of TTL levels or voltage pulses is selected for Outputs 1 and 2, the voltage levels for both outputs should be the same.

Options

- No code:** None
- /A:** Sensor power supply: 24V DC (±10%), 2-wire type
 - /B:** Sensor power supply: 12V DC (±10%), 2-wire type
 - /C:** Sensor power supply: 24V DC (±10%), 3-wire type
 - /D:** Sensor power supply: 12V DC (±10%), 3-wire type
 - /T:** Pulse Hold Function provided.
 - /X:** Others (Special order)
- * For non-standard options, ask MTT for availability.

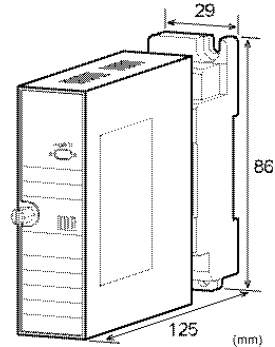

ORDERING INFORMATION

To place an order, please use the ordering code format as shown on the left. (e.g.) MS3709-A-D11

Other Ordering Examples:

For an input code of "Y": MS3709-A-Y11 (Input DC voltage pulse: 0 to 12V / SH = 8.5V, SL = 2.5V)

For an input code of "Y": MS3709-A-Y11 (Input AC pulse: 200Vp-p / S = 2Vp-p)

For an option code of "T": MS3709-A-D11/CT (Pulse hold time: 200ms)

* SH = Threshold level HI, SL = Threshold level LO, S = Threshold level

Note 1: Specify a pulse width between 200µs and 500ms.

Note 2: When a DC current pulse is selected for input, the range should be specified between 0-100µA and 0-100mA.

Note 3: If you wish to include multiple options in your order, specify the option codes in series (e.g. /AX).

SPECIFICATIONS

POWER SECTION

Power Requirements	100 to 240V AC: 85 to 264V AC (47 to 63Hz)
	24V DC: 24V DC±10%
	100 to 240V DC: 85 to 264V DC

Power Sensitivity	Better than ±0.1% of span for each power supply range.
-------------------	--

Power Line Fuse	160mA fuse is installed (standard).
-----------------	-------------------------------------

Power Consumption

Power	100-240V AC	24V DC	100-240V DC
Single Output	5.0VA max	2.1W max	7.2W max
Dual Output	5.5VA max	2.2W max	7.2W max

INPUT SECTION

Input Resistance

Voltage Input (DC)	With power:	1MΩ min. (Standard, 5V input)
	Without power:	10kΩ min.
Current Input (DC)	250Ω (Standard for 4 to 20mA)	

Note: When a 2-wire type sensor power supply is specified, a shunt resistor of 100Ω is used.

Allowable Input Voltage		
DC Voltage Input Model	30V DC max., continuous.	
DC Current Input Model	40mA DC max., continuous.	
AC Voltage Input Model	200V _{p-p} AC max., continuous (up to ±100V with reference to 0V).	
Input Pulse Width	10µs min. (for both ON and OFF)	
Sensor Power Supply	30mA max. (2-wire or 3-wire type)	
Ranges Available		
	AC Voltage Pulse	DC Voltage Pulse
Input Range	-300 to 300V	0 to 300V
Input Voltage Span	0.1 to 600V _{p-p}	1 to 300V
Input Bias	N/A	0 to +300%
Threshold Voltage	50mV _{p-p} min.	Hi-Lo voltage: 0.2V min.
Input Spec. Ex.: For 10 to 15V DC voltage pulse input, the input span is 5V and the bias +200%.		

● OUTPUT SECTION

Maximum Output Load	
TTL Level	(Maximum output 10mA @ 3.5V)
Voltage Pulse 10V	(Maximum output 7mA @ ±10%)
Voltage Pulse 12V	(Maximum output 7mA @ ±10%)
Maximum Rating	Open collector (Maximum rating: 30V, 100mA)
Maximum Output Frequency without Pulse Hold Function	Voltage Pulse Output: 50kHz Open Collector Output: 20kHz (For both of the above, the conditions are as follows: input pulse duty ratio 50% and standard threshold voltage.)
Maximum Output Frequency with Pulse Hold Function	When a pulse hold time is specified, the maximum possible output frequency is determined by: $Hz = 1 / (T \times 1.2 + 10\mu s^*)$ * 10µs: Output pulse Lo level for TTL and voltage pulse outputs or output pulse ON for open collector output. (Example) When a pulse hold time of 200ms is set, the maximum output frequency is: $1 / (0.2 \times 1.2 + 0.0001) = 4.166Hz$
Duty Ratio	50% typical (Input pulse duty ratio 50%, standard threshold voltage) DC voltage pulse: 0-5V/1kHz input AC voltage pulse: 5V _{p-p} /1kHz input Open collector: 1kHz input
Polarity Reversing Function	See the Output Logic Table below.

● OUTPUT LOGIC

Input Signal	Input Waveform	Polarity Reversing Switch	Voltage Pulse Output	Open Collector Output
Voltage Pulse		NORMAL		
		REVERSE		
Open Collector		NORMAL		
		REVERSE		

● PERFORMANCE

Output Pulse	Better than ±20% of a user-specified value.
Hold Time Accuracy	
Isolation	4-way isolation between input, output [Output 1/Output 2], power, and ground.
Insulation Resistance	100MΩ min. (@ 500V DC) between input, output [Output 1/Output 2], power, and ground.
Dielectric Strength	Input / Output [Output 1/Output 2] / [Power, Ground]: 2000V AC for 1 minute (Cutoff current: 0.5mA) Power / Ground: 2000V AC for 1 minute (Cutoff current: 5mA) Output 1 / Output 2: 500V AC for 1 minute (Cutoff current: 0.5mA)
Surge Withstand Capability	Tested as per ANSI/IEEE C37.90.1-1989.
Operating Environment	Ambient temperature: -5 to 55°C Humidity: 5 to 90% RH (non-condensing)
Storage Temperature	-10 to 60°C

● PHYSICAL

Installation	Wall/DIN rail mounting
Wiring	M3.5 screw terminal connection (with a power terminal block cover & drop-proof screws)
Screwing Torque	0.8 to 1.0 [Nm] * Recommended
External Dimensions	W29 × H86 × D125mm (including the mounting screw and socket)
Weight	Main unit: 120g max. Socket: 80g max.

● MATERIAL

Housing	ABS resin (UL 94V-0)
Terminal Block	PBT resin (UL 94V-0)
Terminal Block Cover	PC resin (UL 94V-2)
DIN Rail Stopper	PP resin (UL 94HB)
Screw Terminal	Nickel-plated steel
Contacts Material and Finish	Brass with 0.2µm gold plating
Printed Circuit Board	Glass fabric epoxy resin (FR-4: UL 94V-0)
Conformal Coating	HumiSeal® 1A27NSLU (Polyurethane)

* HumiSeal® is a registered trademark of Chase Corporation.

● STANDARDS CONFORMITY

EC Directive Conformity	EMC Directive (2014/30/EU) EN61326-1: 2013 Low Voltage Directive (2014/35/EU) IEC61010-1/EN61010-1: 2010 Installation Category II Pollution Degree 2 Maximum operating voltage 300V Reinforced insulation between [input/output/GND] and power.
-------------------------	--

TERMINAL ASSIGNMENT

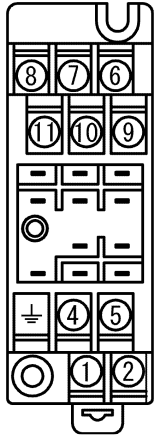

①	P (+)	POWER
②	N (-)	
③	GND	
④	+ OUTPUT 1	
⑤	- OUTPUT 1	
⑥	N.C.	
⑦	+ OUTPUT 2	
⑧	- OUTPUT 2	
⑨	+ INPUT	
⑩	- INPUT	
⑪	EX	

BLOCK DIAGRAM

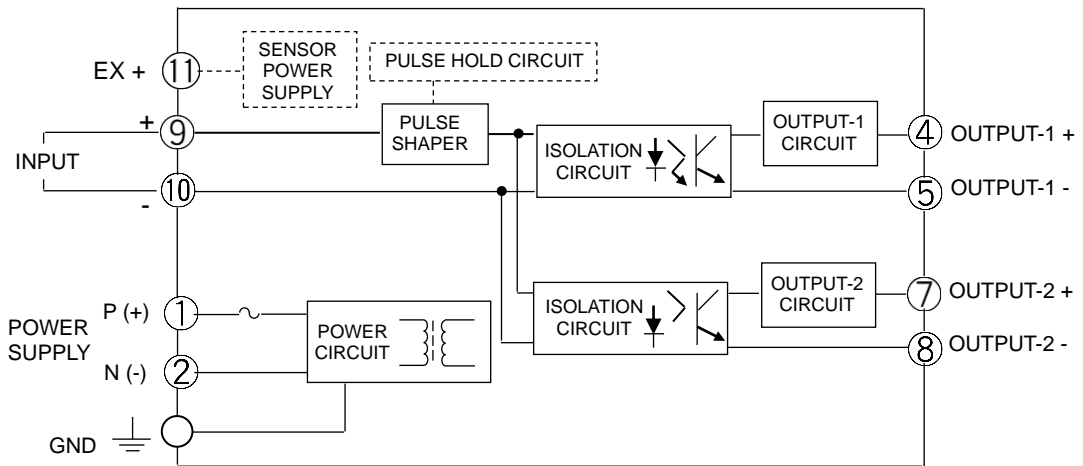

For dry contact or open collector input:

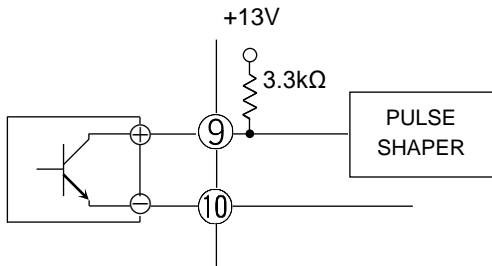

For voltage pulse input:

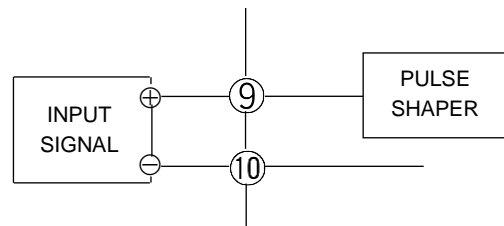

When a 2-wire sensor is used:

Note: The connections may vary depending on the type of the sensor used.

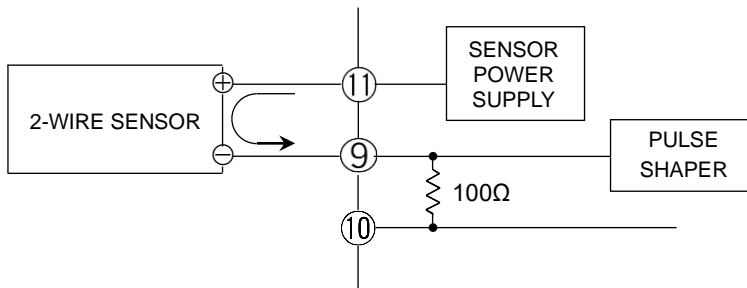

THEORY OF OPERATIONS

Input code O: Open collector input; threshold voltage: approx. 2V

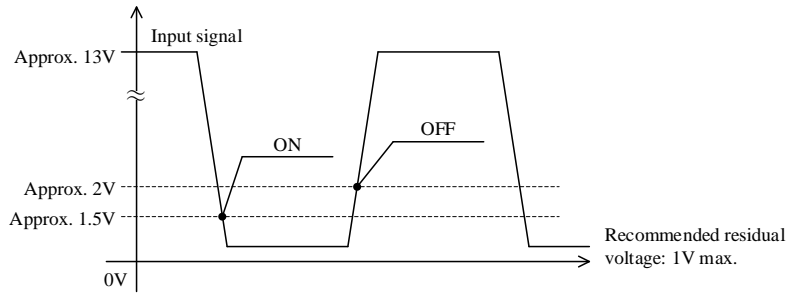

Input code M: Open collector input; threshold voltage: approx. 5V
 This spec. is for input signals with a residual voltage of 1.5V or greater (Azbil's electromagnetic flowmeter MGG10C, etc.).

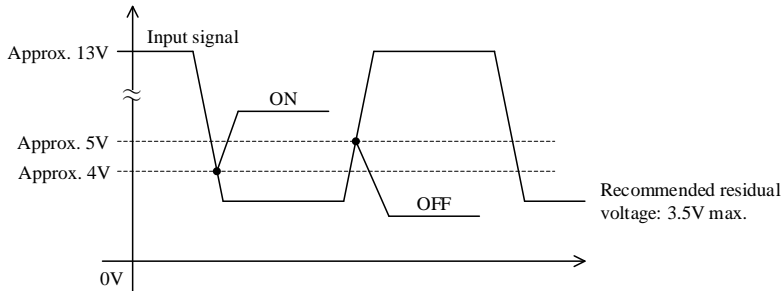

Input code A: AC voltage pulse input; threshold voltage: approx. 0.06Vp-p

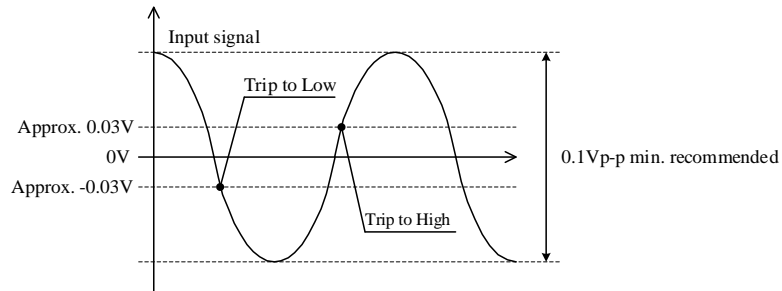

Input code D: DC voltage pulse input; threshold voltage: approx. 2V

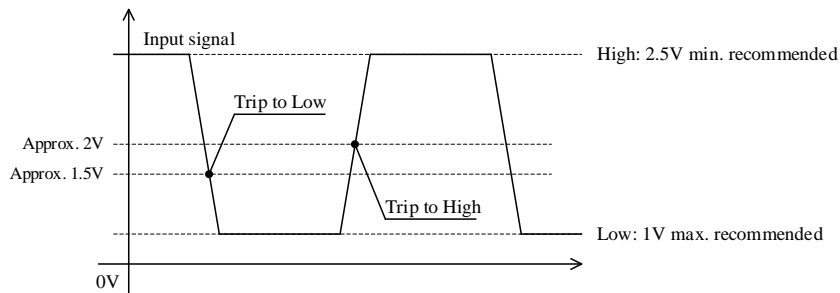

Input code I: 4-20mA DC input; threshold current: approx. 8mA

